



■ Some of the photos may include optional equipment.

We build a better future

FORKLIFT TRUCKS **Environmentally - Friendly**

25L/30L/33L-7A

 **HYUNDAI**
CONSTRUCTION EQUIPMENT AMERICAS, INC.

NEW criteria of Forklift Trucks

Hyundai introduces a new line of 7A series
LPG forklift trucks.
Excellent power and performance make your
business more profitable.



OPSS (Operator Presence Sensing System)

Control of mast tilting, lifting and lowering is not possible through operation of the appropriate control when the operator is not in the seated position. (Option)

■ Some of the photos may include optional equipment.



The new master on the job-site!

Smooth running, efficient and ergonomically designed, 25L/30L/33L-7A are made to meet your needs.

59hp/ 2,300rpm

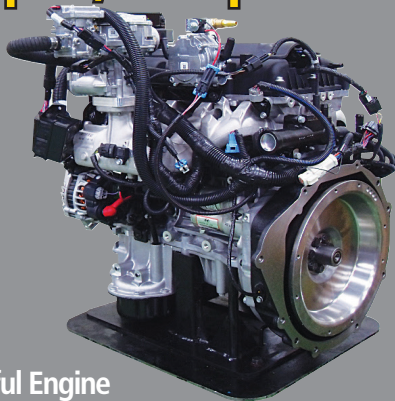

Powerful Engine HMC L4KB(2.4L) Engine

Market approved quality of HMC L4KB engine ensures incomparable performance, durability and additional value to the machine. Powerful and efficient engine provides excellent fuel consumption and excellent torque improved operator's comfort.
(EPA/CARB Tier-IV Certified)

Fast and Stable Performance

Being able to quickly raise and lower the mast, as well as tilt it forward and backward, provides the best operational conditions during unloading. When the truck is fully loaded, mast lowering speed is carefully controlled to ensure safety by the down control valve. Mast(Lift and Tilt) Look System. (Option)

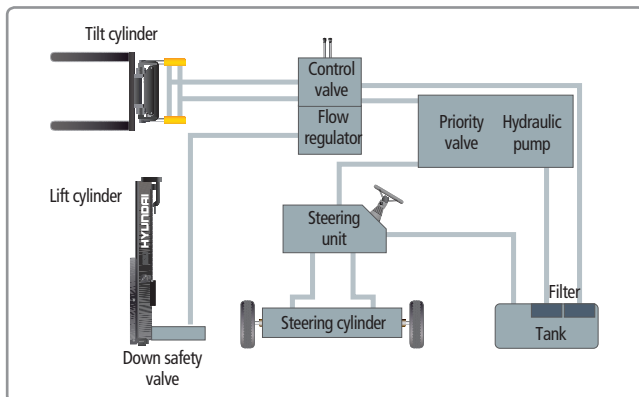
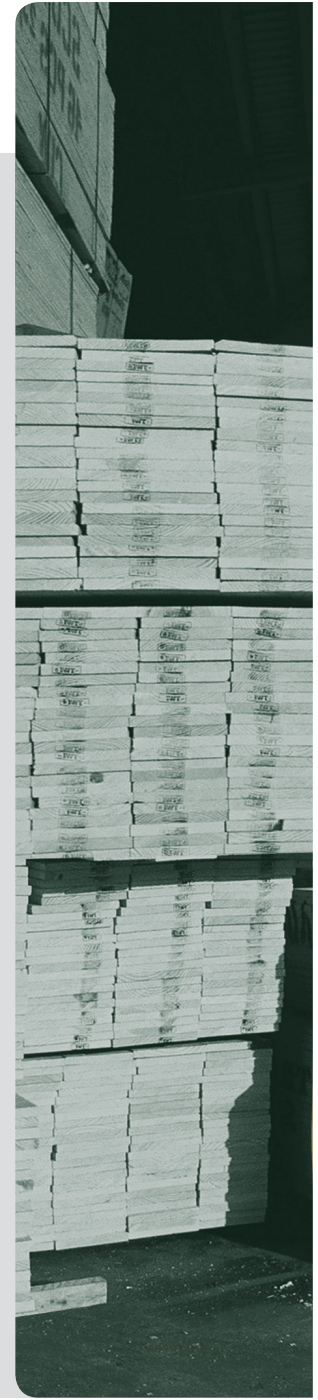

State-of-the-art Hydraulic System

The latest large-capacity hydraulic system reacts quickly during operation, and a low-noise control valve increases both efficiency and durability.



Fully Hydrostatic Power Steering

A hydraulic steering system always guarantees smooth and flexible steering, preventing overrun and kick-back.



**High Power
Low Noise**

■ Some of the photos may include optional equipment.



Increased Mast Tilting Angle
Utilizing the mast tilting angle of 6 degrees forward and 10 degrees backward, the operator can safely and rapidly perform loading and unloading jobs.

Faster Travel Speed & Better Gradability

The powerful high-output engine provides dynamic, acceleration, untiring gradability and optimal travel speed on any tough terrains or slopes.



Gradability(Loaded)

- 25L-7A: 20.4°
- 30L-7A: 16.6°
- 33L-7A: 15.4°

Travel Speed(Unloaded)

- 25L-7A: 11.0 mph
- 30L-7A: 11.6 mph
- 33L-7A: 11.6 mph

Ergonomic operator friendly compartment design!

A design based on human engineering relieves fatigue and increases operator's efficiency.

Operator Friendly Gauges and Water-resistant Monitor Panel

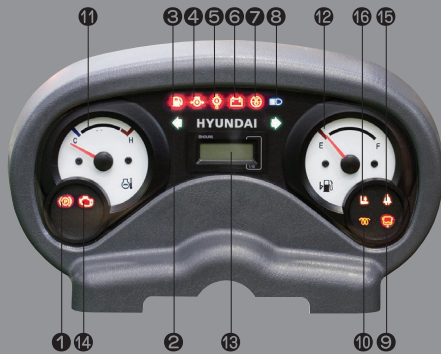

- | | | |
|---|------------------------------------|----------------------|
| 1 Parking brake lamp | 6 Battery charging warning lamp | 12 Fuel gauge |
| 2 Directional indicators | 7 Air cleaner filter warning light | 13 Hour meter |
| 3 Fuel warning lamp | 8 Working light indicator | 14 Engine check lamp |
| 4 Engine oil warning lamp | 9 Water separator lamp | 15 Seat belt warning |
| 5 Transmission oil temperature warning lamp | 10 Pre-heater indicator | 16 OPS warning |
| | 11 Water temperature gauge | |



Full Suspension Seat

An attractive and adjustable seat, based on a human engineering design, provides great comfort, safety and durability.



New High Visibility for Safe Operation

The operator is able to work with increased safety and accuracy due to a wider view mast.

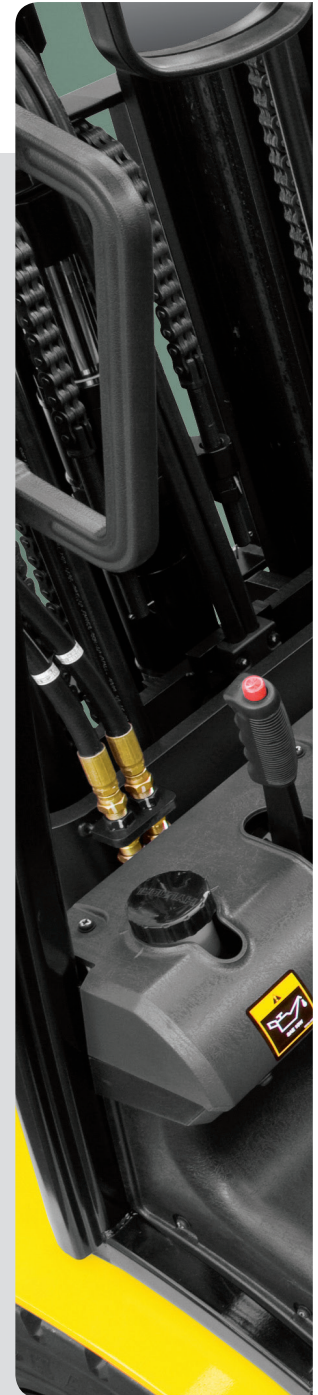

Ergonomically Positioned Pedals

Based on human engineering, the accelerator, brake and inching pedals are optimally positioned for convenience while operating the equipment.

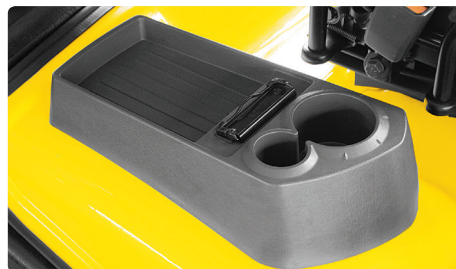

Cup Holder & Console Box

Additional storage spaces are located inside the operating space for operator's convenience.



Quick Response of Operating Control Levers

Only minimal operator's effort is required for precise, safe and productive control.



Travel Speed Control System (Option)

← In-Door : Max. Travel Speed 3~10 mph

← Out Door : Max Vehicle Travel Speed

■ Some of the photos may include optional equipment.



Adjustable Steering Wheel

Steering wheel with horn button can be adjusted by a lever on the right-hand side for the most comfortable operator position.



Easy and Safe Shift Lever

A single lever on the left side of the steering column gives the operator fast, easy control of direction. The lever must be in the neutral position before the engine can be started.



Secondary Horn

Secondary Horn gives access to lights and horn

Danger-free through high durability!

Safety and durability are priorities in design of the equipment.



Strong Overhead Guard

The safety overhead guard meets ISO 6055 regulation and protects the operator during hazardous jobs.

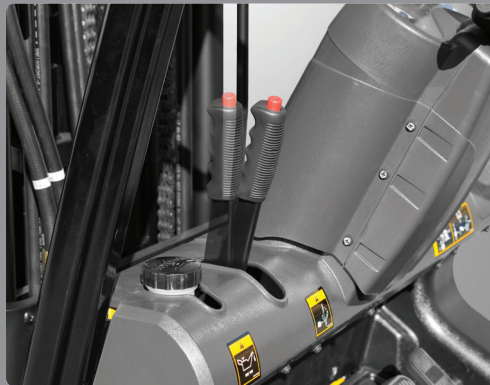

Parking Brake

Ratchet type parking brake requires less effort from the operator to set.

Highly Durable Split Type Drive Axle

The bevel gear set and hub reduction axle smoothly delivers desired torque to the drive wheels.

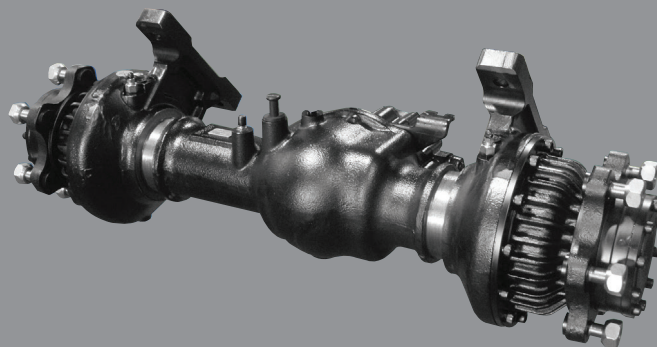

Large Footboard & Hand Grip

Wide "open" step offers convenience and safety when entering and exiting truck.



Expansion Bellows

The expansion bellows absorbs vibration and reduces noise generated from the exhaust gas system and also extends the life cycle of exhaust gas system.



Electrically Monitored Air Filter

Air cleaner sensor alerts the operator of a restricted air filter and allows replacement before damage occurs.





■ Some of the photos may include optional equipment.

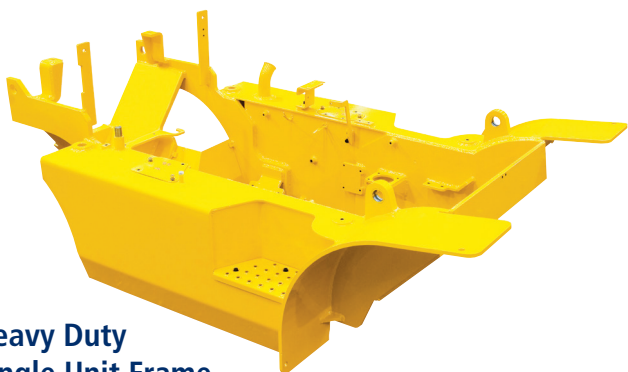

Heavy Duty Single Unit Frame

Heavy duty single unit type frame, designed on the basis of accurate structural analysis, guarantees durability and safety.



Bright, Protected Headlights

Bright, Protected head lights are positioned for exceptional visibility.

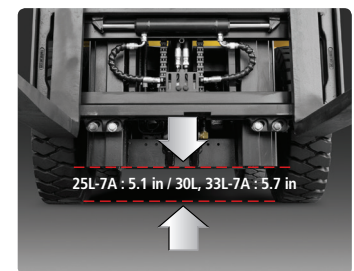

Ground Clearance

The engine and transmission are assembled horizontally and positioned high in the frame to protect major components during operation on rugged surface.

Designed for quick and easy service!

An ideal arrangement of component parts ensures easy access and convenience for maintenance.



Easy Change Air Cleaner

The air filter is readily accessible for cleaning or replacement. (6inch Cyclone Type)



Fast Service Access for Daily Fluids Check

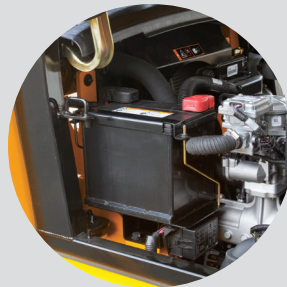

Rotational Battery Installation



One Touch, No Tool Floor Plate



Removable Side Panels for Ease of Service



Improvement in Maintenance of Electric Parts

Various electric parts are centralized in dash board resulting in effortless troubleshooting.

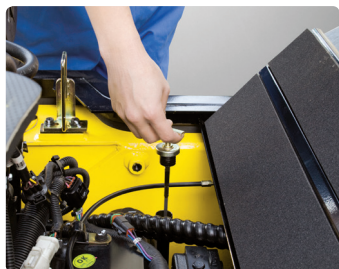

Easy Maintenance Oil Check

The T/M oil level can be checked easily without any disassembly.

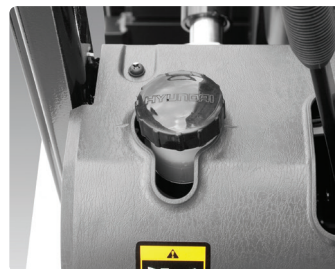

Brake Fluid Reservoir

Highly visible, easily accessible reservoir makes for quicker daily inspections.



An Accessible, Compact Fuse Box for Easy Inspection

Mast Specification

Mast Type	Maximum Fork Height (in)		Overall Height Lowered (in)			Free Lift (in)						Tilt Angle (deg)		Load Capacity w/o Integral Side Shift 24in LC (lb)						Load Capacity w/ Integral Side Shift 24in LC (lb)						Truck Weight Unload (lb)									
	25L-7A 30L-7A		25L-7A	30L-7A	33L-7A	With Backrest			With / o Backrest			Fwd	Bwd	Single Tire			Double Tire			Single Tire			Double Tire			Single Tire			Double Tire						
	25L-7A	30L-7A	25L-7A	30L-7A	33L-7A	25L-7A	30L-7A	33L-7A	25L-7A	30L-7A	33L-7A	25L-7A	30L-7A	33L-7A	25L-7A	30L-7A	33L-7A	25L-7A	30L-7A	33L-7A	25L-7A	30L-7A	33L-7A	25L-7A	30L-7A	33L-7A	25L-7A	30L-7A	33L-7A						
2-Stage Limited Free Lift	V300	118.1	2900	79.7	2040	2040	6.1	155	155	6.1	155	155	6	10	5000	6000	6500	5000	6000	6500	5000	6000	6500	5000	6000	6500	5000	6000	6500	8260	9364	9733	8560	9555	9947
	*V330	129.9	3200	85.6	2190	2190	6.1	155	155	6.1	155	155	6	10	5000	6000	6500	5000	6000	6500	5000	6000	6500	5000	6000	6500	5000	6000	6500	8303	9408	9785	8603	9599	9999
	V350	137.8	3400	89.6	2290	2290	6.1	155	155	6.1	155	155	6	10	5000	6000	6500	5000	6000	6500	5000	6000	6500	5000	6000	6500	5000	6000	6500	8340	9448	9820	8641	9638	10034
	V370	145.7	3600	95.5	2440	2440	6.1	155	155	6.1	155	155	6	10	5000	6000	6500	5000	6000	6500	4820	6000	6500	5000	6000	6500	4820	6000	6500	8389	9498	9872	8689	9689	10086
	V400	157.4	3900	101.4	2590	2590	6.1	155	155	6.1	155	155	6	10	4930	6000	6500	5000	6000	6500	4750	5920	6500	4820	6000	6500	4750	5920	6500	8455	9566	9943	8755	9757	10157
	V430	169.3	4200	107.3	2740	2740	6.1	155	155	6.1	155	155	6	6	4850	5840	6500	5000	6000	6500	4670	5660	6500	4820	5950	6500	4670	5660	6500	8569	9682	10061	8869	9873	10275
	V450	177.2	4400	113.2	2890	2890	6.1	155	155	6.1	155	155	6	6	4740	5730	6500	4938	1900	6500	4560	5550	6500	4758	1720	6500	4560	5550	6500	8618	9732	10113	8918	9923	10327
	V470	185.0	4600	117.1	2990	2990	6.1	155	155	6.1	155	155	6	6	4630	5510	6500	4850	5790	6500	4450	5330	6500	4670	5780	6500	4450	5330	6500	8649	9765	10148	8950	9956	10362
2-Stage Full Free Lift	V500	196.9	4900	123.0	3140	3140	6.1	155	155	6.1	155	155	6	6	4400	4740	6500	4630	5680	6500	4220	4560	6460	4450	5620	6500	4220	4560	6460	8698	9816	10200	8998	10007	10414
	VF290	115.4	2900	79.7	2040	2090	33.3	860	910	54.2	1314	1269	6	6	5000	6000	6500	5000	6000	6500	5000	6000	6500	5000	6000	6500	5000	6000	6500	8361	9453	9830	8663	9643	10031
VF320	127.2	3200	85.6	2190	2240	39.2	1010	1060	60.1	1464	1419	6	6	5000	6000	6500	5000	6000	6500	5000	6000	6500	5000	6000	6500	5000	6000	6500	8435	9530	9908	8737	9720	10109	
3-Stage Full Free Lift	TF370/TS370	145.7	3700	71.9	1840	1890	25.4	660	710	46.3	1114	1069	6	6	4930	6000	6500	5000	6000	6500	4750	5950	6500	4820	6060	6500	4750	5950	6500	8560	9694	10144	8862	9884	10345
	TF400/TS400	157.4	4000	75.8	1940	1990	29.3	760	810	50.3	1214	1169	6	6	4820	5840	6500	4930	6000	6500	4640	5780	6500	4750	5890	6500	4640	5780	6500	8613	9748	10193	8915	9937	10394
	TF430/TS430	169.3	4300	79.7	2040	2090	33.3	860	910	54.2	1314	1269	6	6	4710	5730	6500	4850	5880	6500	4530	5670	6500	4670	5780	6500	4530	5670	6500	8653	9796	10239	8955	9986	10440
	TF450/TS450	177.2	4500	83.7	2140	2190	37.2	960	1010	58.1	1414	1369	6	6	4540	5660	6500	4760	5760	6500	4360	5560	6430	4580	5670	6500	4360	5560	6430	8701	9852	10287	9004	10042	10488
	TF470/TS470	185.0	4700	85.6	2190	2240	39.2	1010	1060	60.1	1464	1419	6	6	4400	5400	6500	4670	5660	6500	4220	5220	6390	4490	5480	6500	4220	5220	6390	8731	9884	10317	9033	10073	10517
	TF500/TS500	196.5	5000	89.6	2290	2340	43.1	1110	1160	64.1	1564	1519	6	6	3520	4630	6480	4580	5510	6500	3340	4450	6260	4400	5330	6500	3340	4450	6260	8780	9933	10366	9082	10123	10567
	TF550/TS550	216.5	5500	97.4	2490	2540	51.0	1310	1360	71.9	1764	1719	6	6	2640	3040	4400	4400	5290	6500	2460	2860	4190	4220	5110	6390	2460	2860	4190	8866	10030	10463	9168	10220	10664
	TF600/TS600	236.2	6000	105.3	2690	2740	58.9	1510	1560	79.8	1964	1919	6	6	1760	2020	2420	3520	4630	6390	1580	1840	2200	3340	4450	6170	9009	10184	10623	9311	10374	10823			
4-Stage Full Free Lift	QF610	240.7	6115	85.0	2175	2225	39.3	995	1045	59.5	1449	1449	3	3	3310	3730	4300	3810	4850	6240	3170	3550	4080	3520	4590	6060	3170	3550	4080	9473	10509	10786	9773	10701	10955
	QF660	260.4	6615	92.9	2375	2425	47.1	1195	1245	67.4	1649	1649	3	3	3110	3530	4080	3590	4520	5950	2950	3350	3860	3420	4280	5730	2950	3350	3860	9603	10642	10918	9903	10833	11088
	QF700	276.2	7015	96.8	2475	2525	51.1	1295	1345	71.3	1749	1749	3	3	2910	3110	3300	3510	4430	5690	2780	2950	3080	3310	4190	5420	2780	2950	3080	9672	10708	10985	9971	10899	11153
	QF745	293.9	7465	102.8	2625	2675	57.0	1445	1495	77.2	1899	1899	3	3	2290	2510	2200	3310	4230	5380	2160	2360	1980	3150	3990	5160	2160	2360	1980	9773	10809	11086	10073	11001	11255
	QF790	311.6	7915	108.7	2775	2825	62.9	1595	1645	83.1	2049	2049	3	3	1480	1570	1210	2090	2290	2860	1370	1430	1100	1920	2070	2640	9993	11032	11308	10293	11224	11476			

* TS-Mast : Wide Visible 3 Stage Full Free Lift Mast with 2 Free Lift Cylinders.

Load Capacity

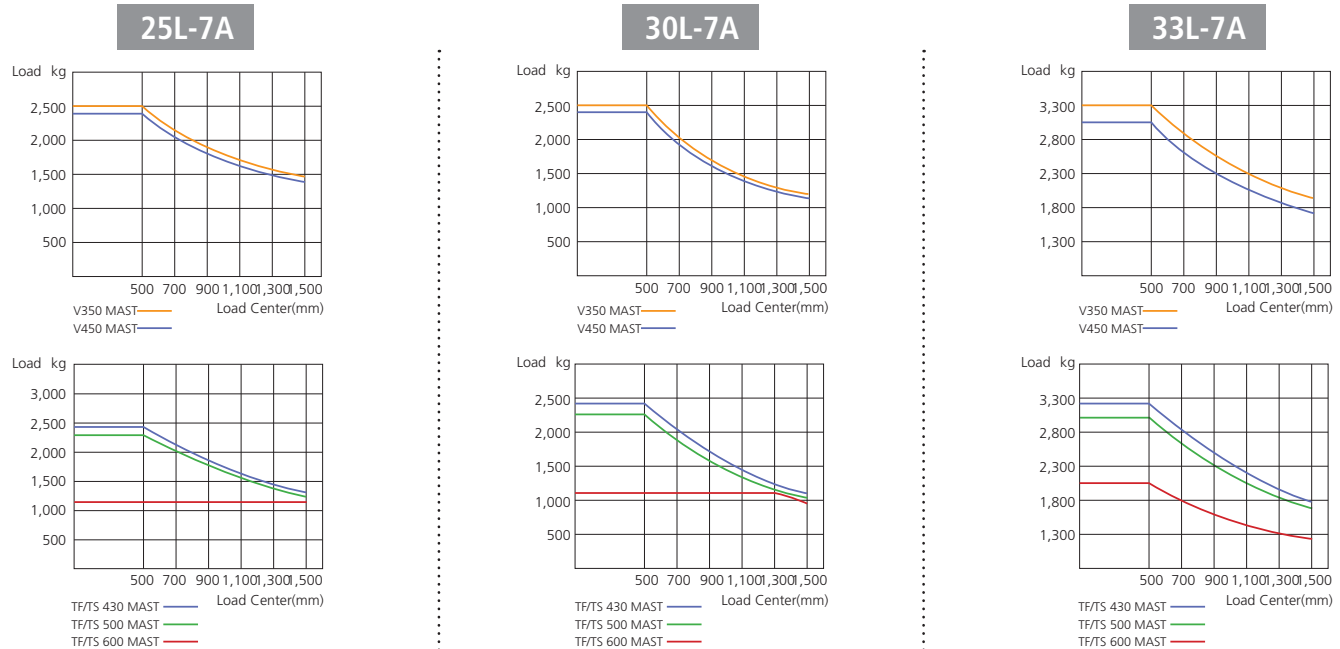

Optional Items

- CABIN & HEATER
- SIDE SHIFT / INTEGRAL SIDE SHIFT
- OVER SHOE(mm) : 51.2 / 59.1 / 66.9 / 70.9
- FORK (L x W x T) (in)

25L-7A

35.4 x 3.9 x 1.8	39.4 x 3.9 x 1.8	41.3 x 3.9 x 1.8
47.2 x 3.9 x 1.8	53.1 x 3.9 x 1.8	59.1 x 3.9 x 1.8
65.0 x 3.9 x 1.8	70.9 x 3.9 x 1.8	

30/33L-7A

35.4 x 4.8 x 1.8	41.3 x 4.8 x 1.8	45.3 x 4.8 x 1.8
47.2 x 4.8 x 1.8	53.1 x 4.8 x 1.8	59.1 x 4.8 x 1.8
65.0 x 4.8 x 1.8	70.9 x 4.8 x 1.8	77.6 x 4.8 x 1.8
83.5 x 4.8 x 1.8	90.6 x 4.8 x 1.8	94.5 x 4.8 x 1.8

- TILTING : 6/6°, 3/3°
- TIRE : No-marking, Double
- SEAT : Pocket, Belt, Arm Rest, Hip Rest

- LPG TANK CLAMP : Swing Out, Swing Down
- M.C.V : 4-Spool
- ATTACH PIPING : 3 Spool-piping, 4 Spool-piping
- MASTER SWITCH / HAZARD SWITCH
- BEACON LAMP / WORK LAMP
- TRAVEL SPEED CONTROL SENSOR
- TS-MAST
- PRECLANER • OPSS : Travel + Mast

Dimension

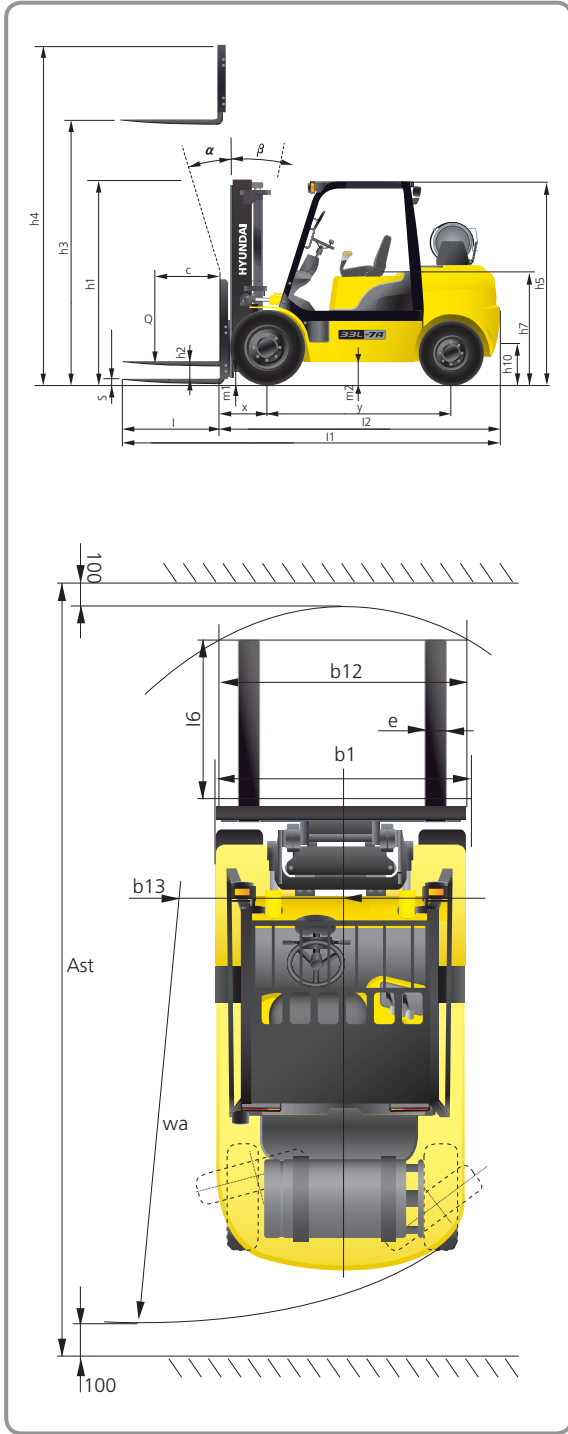

Specification

Identification			
1.1	Manufacturer	Hyundai	Hyundai
1.2	Manufacturer's type designation	25L-7A	30L-7A
1.3	Drive: electric (battery or mains), diesel, petrol, fuel gas, manual	LP	LP
1.4	Type of operation: hand, pedestrian, standing, seated, order-picker	seated	seated
1.5	Load capacity / rated load	Q (lb)	5,000
1.6	Load center distance	c (in)	24
1.8	Load distance, center of drive axle to fork	x (in)	18.4
1.9	Wheelbase	y (in)	65
Weights			
2.1	Service weight	lb	8,152
2.2	Axle loading, loaded front/rear	lb	11,995 / 1,657
2.3	Axle loading, unloaded front/rear	lb	3,268 / 4,884
Wheels, Chassis			
3.1	Tires: solid rubber, superplastic, pneumatic, polyurethane	Pneumatic	Pneumatic
3.2	Tires size, front	7.00 - 12	8.15 x 15
3.3	Tires size, rear	6.50 - 10	6.50 - 10
3.5	Wheels, number front x rear (x = driven wheels)	2 x 2	2 x 2
3.6	Track width, front	b10 (in)	38
3.7	Track width, rear	b11 (in)	38.6
Basic Dimensions			
4.1	Mast / fork carriage tilt forward / backward(α / β)	degrees	6 / 10
4.2	Lowered mast height	h1 (in)	85.6
4.3	Free lift	h2 (in)	6.1
4.4	Lift height	h3 (in)	130
4.5	Extended mast height	h4 (in)	176.6
4.7	Overhead load guard (cab) height	h5 (in)	85(86.5)
4.8	Seat height / standing height	h7 (in)	43.7
4.12	Coupling height	h10 (in)	11.1
4.20	Length to face of forks	l2 (in)	102.1
4.21	Overall width	b1 (in)	45.7
4.22	Fork dimensions	s / e / l (in)	41.3 x 3.9 x 1.8
4.23	Fork carriage ISO 2328, class / type A,B		II A
4.24	Fork-carriage width	b12 (in)	43.4
4.31	Ground clearance, loaded, under mast	m1 (in)	5.1
4.32	Ground clearance, centre of wheelbase	m2 (in)	6.7
4.33	Aisle width for pallets 1000 x 1200 crossways	Ast (in)	3,966
4.34	Aisle width for pallets 800 x 1200 lengthways	Ast (in)	4,166
4.35	Turning radius	Wa (in)	90.5
4.36	Smallest pivot point distance	b13 (in)	28.1
Performance Data			
5.1	Travel speed, Unloaded	mph	11.0
5.2	Lift speed, Loaded/Unloaded	fpm	23.6 / 24.0
5.3	Lowering speed, Loaded/Unloaded	fpm	19.7 / 17.7
5.5	Drawbar pull, Loaded	lb	5,318
5.7	Gradient performance, Loaded	%	37.1
5.9	Acceleration time, loaded/unloaded (10m)	sec	-
5.10	Service brake		WET DISC
Engine			
6.1	Engine manufacturer / type		HMC L4KB
6.2	Engine power acc. to ISO 1585	hp	59
6.3	Rated speed	1/min	2,300
6.4	No. of cylinder / cubic capacity	/in ³	4 / 144
Other Details			
8.2	Type of drive control		Power Shift
8.3	Operating pressure	bar	220 / 165
8.4	Oil volume	ℓ	30



6100 Atlantic Blvd Norcross, GA 30071
 TEL (678) 823 7777 FAX (678) 823 7778

PLEASE CONTACT

www.hceamericas.com

2015. 03 Rev. 0